

FLEXIBLES ABGASSYSTEM (FLEX)

DN 60 – 200 mm

PPH

1	Kaminabschluss flex (Komplett)
2	Rohr mit Muffe
3	Revisions-T-Stück flex/flex
4	Revisions-T-Stück flex/starr
5	Abstandhalter
6	Flexrohr
7	Stützbogen 87° mit EST-Auflageschiene flex
8	Abdeckblende mit Hinterlüftung
9	Rev. T-Stück mit Revisionsdeckel
10	Rev. T-Stück mit Ablauf
11	Umlenk. T-Stück mit Revisionsdeckel
12	Kesselanschluss konzentrisch
13	Tür lose

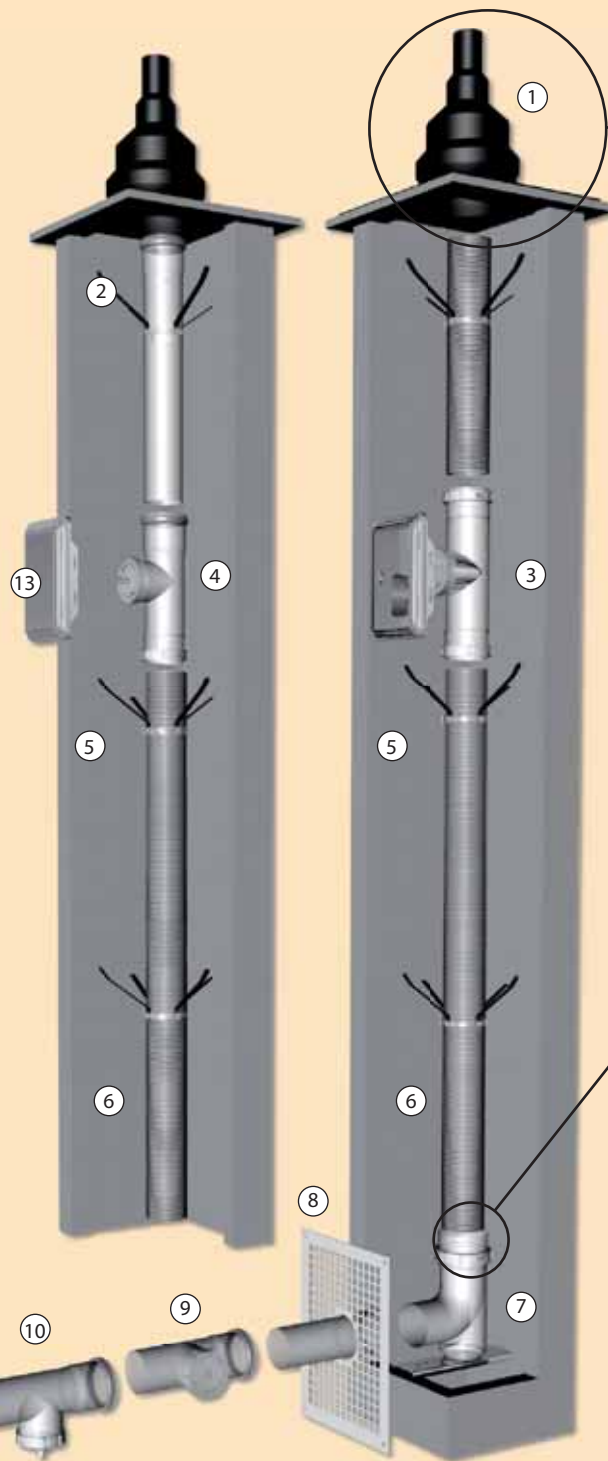

Gefälle schaffen
 waagerechte Verbindungsleitung
 muss zum Kessel immer ein Gefälle
 von mindestens 3° haben

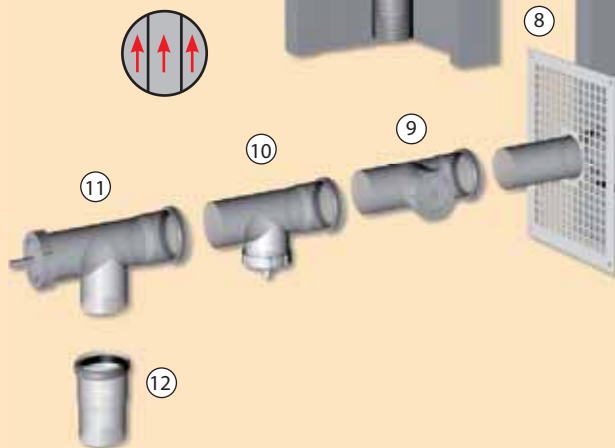

FLEXIBLES ABGASSYSTEM (FLEX)

DN 60 – 200 mm

PPH

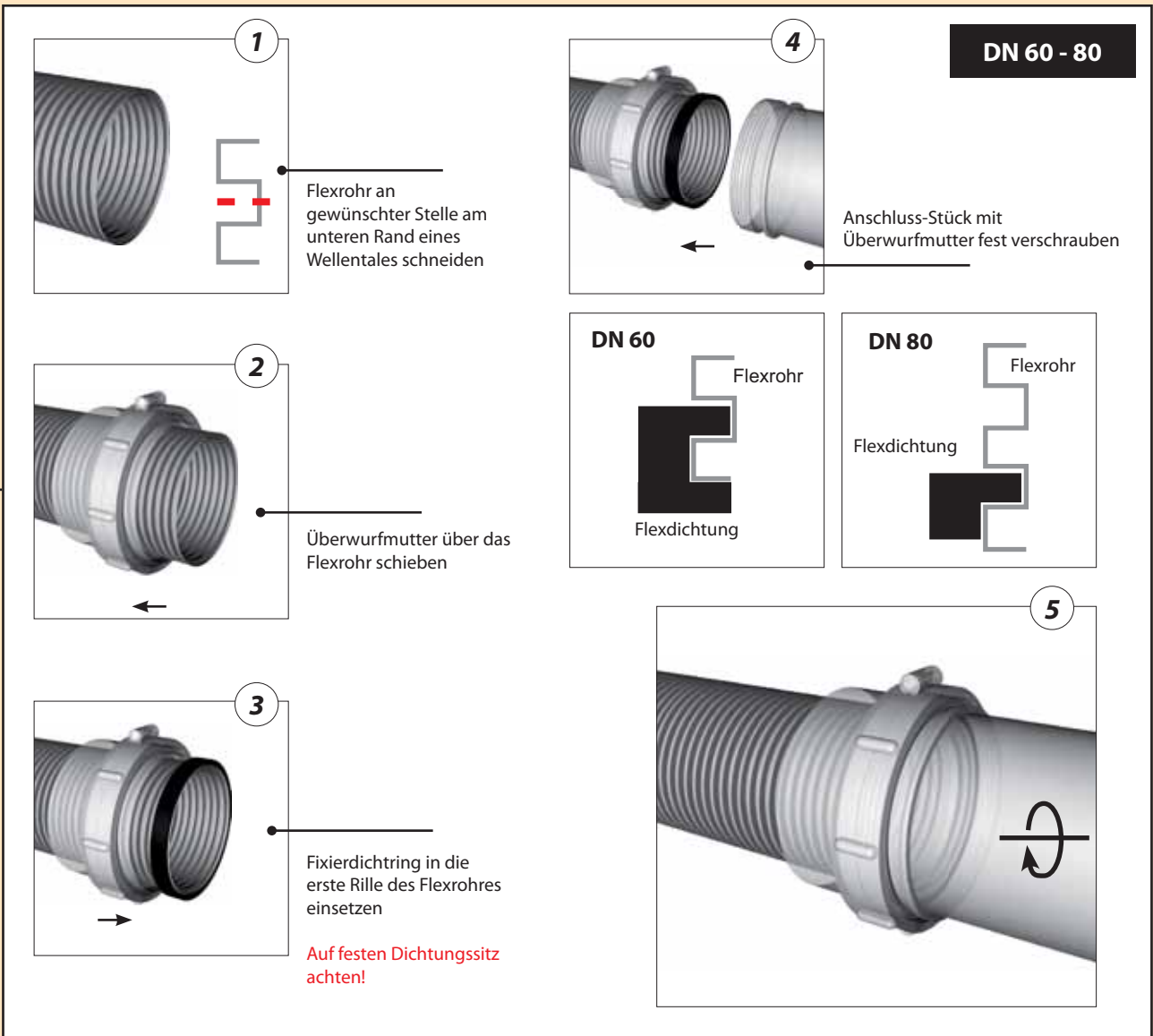
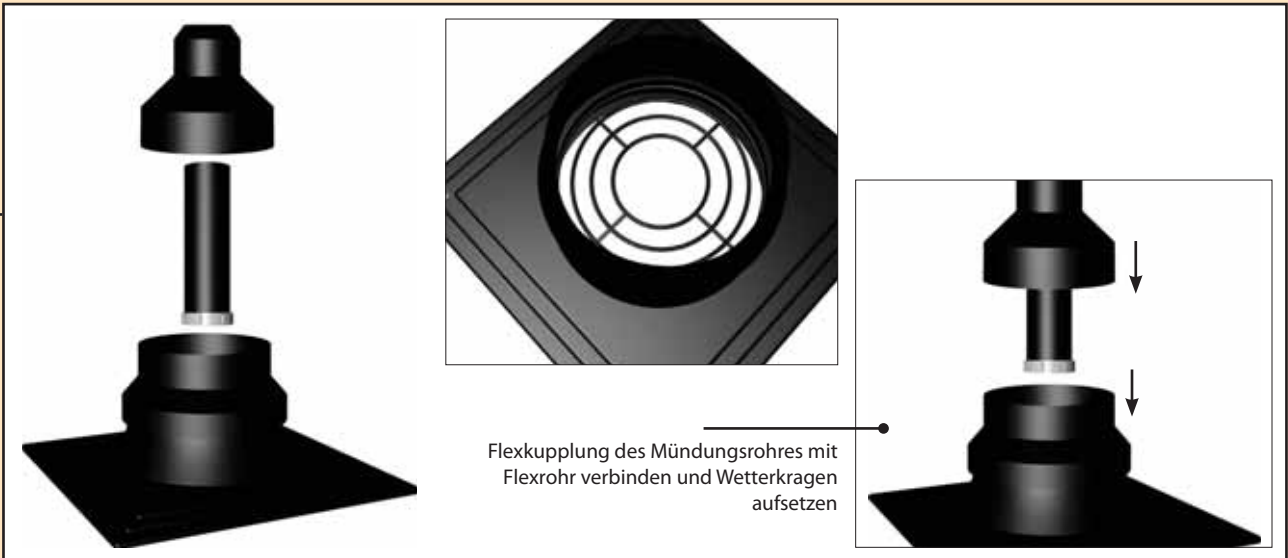

FLEXIBLES ABGASSYSTEM (FLEX)

DN 60 – 200 mm

PPH

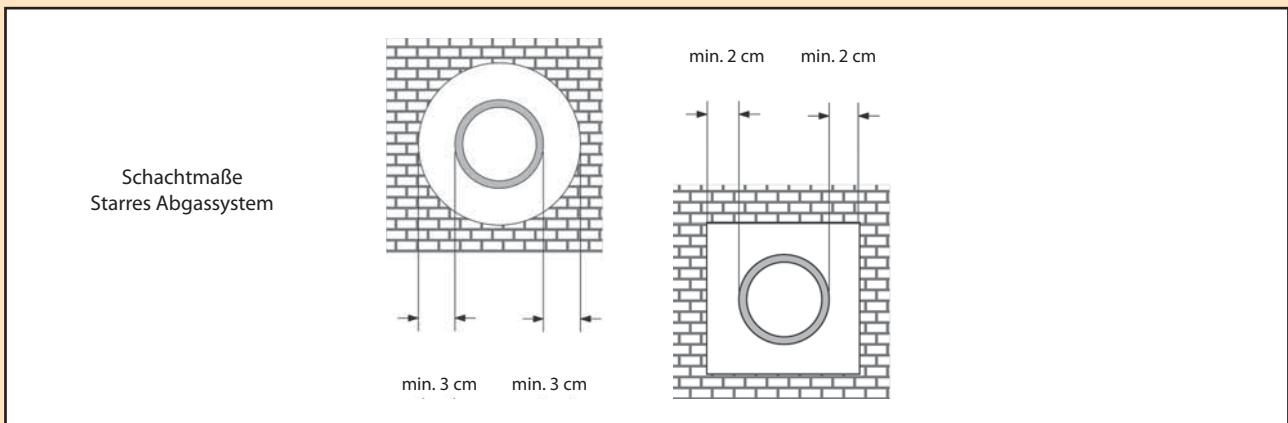
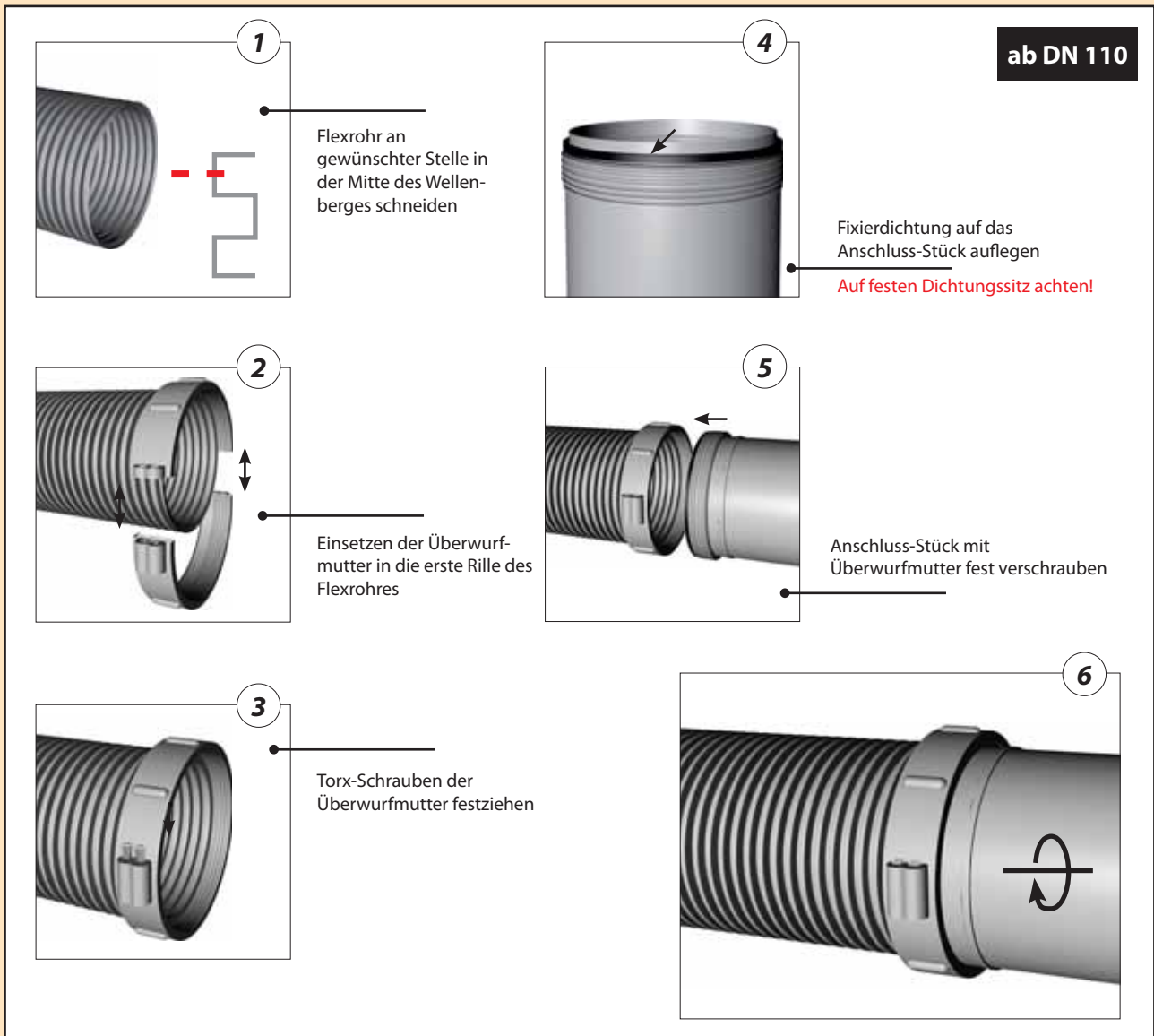



FLEXIBLES ABGASSYSTEM (FLEX)

DN 60 – 200 mm

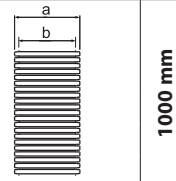
PPH

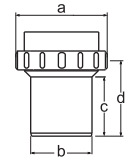
Flexrohr		NW	Art.-Nr.	a (mm)	b (mm)	c (mm)	d (mm)	Notiz
		60	PURF63	63	51	-	-	50 m - Rolle
		80	PURF90	90	76	-	-	30 m - Rolle
		110	PURF25	125	104	-	-	30 m - Rolle
		125	PURF45	145	125	-	-	30 m - Rolle
		160	PURF75	175	157	-	-	25 m - Rolle
		200	PURF00	200	168	-	-	25 m - Rolle

Adapter starr / flex		NW	Art.-Nr.	a (mm)	b (mm)	c (mm)	d (mm)	Notiz
		60	PPAE05	85	60	65	82	
		80	PPAE08	120	80	65	80	
		110	PPAE01	160	110	100	134	
		125	PPAE02	170	125	100	144	
		160	PPAE06	210	160	110	145	
		200	PPAE00	240	200	150	170	

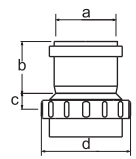
Adapter flex / starr		NW	Art.-Nr.	a (mm)	b (mm)	c (mm)	d (mm)	Notiz
		60	PPAM05	61	68	15	82	
		80	PPAM08	81	68	20	80	
		110	PPAM01	111	68	25	134	
		125	PPAM02	127	74	25	144	
		160	PPAM06	162	83	25	210	
		200	PPAM00	210	150	30	240	

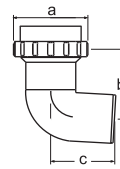
Adapter starr / flex 87°		NW	Art.-Nr.	a (mm)	b (mm)	c (mm)	d (mm)	Notiz
		60	PPAF95	85	82	105	-	
		80	PPAF98	120	120	95	-	
		110	PPAF91	160	145	115	-	
		125	PPAF92	170	140	130	-	
		160	PPAF96	210	145	160	-	
		200	PPAF90	240	300	300	-	

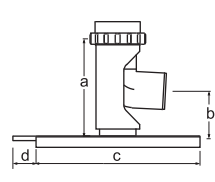
Stützbogen mit EST-Auflage flex u. FK		NW	Art.-Nr.	a (mm)	b (mm)	c (mm)	d (mm)	Notiz
		60	PPTUF5	190	130	350	50	
		80	PPTUF8	170	110	350	50	
		110	PPTUF1	260	130	350	50	
		125	PPTUF2	250	130	350	50	
		160	PPTUF6	280	110	350	50	
		200	PPTUF0	420	130	350	50	

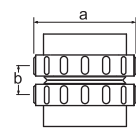
Flexkupplung z. Verbinden v. Flexrohr		NW	Art.-Nr.	a (mm)	b (mm)	c (mm)	d (mm)	Notiz
		60	PPKU05	85	35	-	-	
		80	PPKU08	120	35	-	-	
		110	PPKU01	160	70	-	-	
		125	PPKU02	170	70	-	-	
		160	PPKU06	210	70	-	-	
		200	PPKU00	240	55	-	-	

FLEXIBLES ABGASSYSTEM (FLEX)

DN 60 – 200 mm

PPH

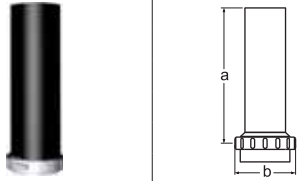
Mündungsrohr flex	NW	Art.-Nr.	a (mm)	b (mm)	c (mm)	d (mm)	Notiz
	60	PPRSF5	270	82	-	-	
	80	PPRSF8	270	80	-	-	
	110	PPRSF1	270	134	-	-	
	125	PPRSF2	270	144	-	-	
	160	PPRSF6	270	210	-	-	
	200	PPRSF0	260	240	-	-	

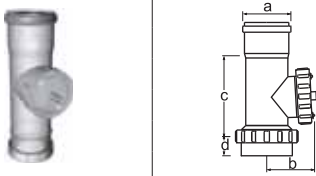
Revisions-T-Stück flex / starr	NW	Art.-Nr.	a (mm)	b (mm)	c (mm)	d (mm)	Notiz
	60	PPRTS5	61	60	110	15	
	80	PPRTS8	81	90	175	30	
	110	PPRTS1	111	115	175	15	
	125	PPRTS2	127	115	250	15	
	160	PPRTS6	162	135	285	15	
	200	PPRTS0	203	155	270	15	

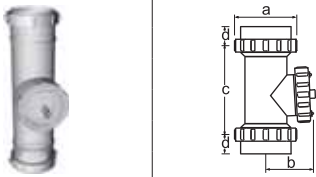
Revisions-T-Stück flex / flex*	NW	Art.-Nr.	a (mm)	b (mm)	c (mm)	d (mm)	Notiz
	60	PPRTF5	85	60	160	15	
	80	PPRTF8	120	90	225	30	
	110	PPRTF1	160	115	210	15	
	125	PPRTF2	170	115	260	15	
	160	PPRTF6	210	135	290	15	
	200	PPRTF0	240	155	240	15	

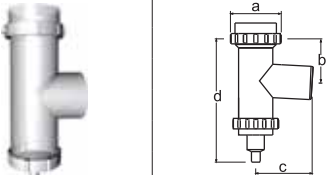
Umlenk-T-Stück mit Ablauf flex	NW	Art.-Nr.	a (mm)	b (mm)	c (mm)	d (mm)	Notiz
	60	PPUAF5	85	60	110	220	
	80	PPUAF8	120	80	120	250	
	110	PPUAF1	160	65	125	200	
	125	PPUAF2	170	105	135	305	
	160	PPUAF6	210	120	180	370	
	200	PPUAF0	240	130	250	380	

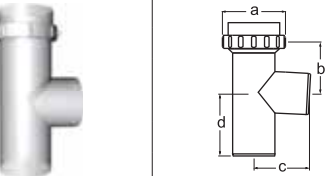
Verbindung-T-Stück starr / flex*	NW	Art.-Nr.	a (mm)	b (mm)	c (mm)	d (mm)	Notiz
	60	PPTEF5	85	60	60	100	
	80	PPTEF8	120	80	90	105	
	110	PPTEF1	160	65	115	110	
	125	PPTEF2	170	105	115	130	
	160	PPTEF6	210	120	135	155	
	200	PPTEF0	240	130	155	260	

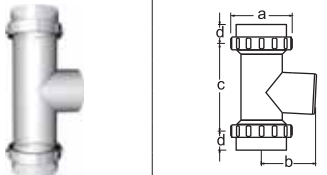
Verbindung-T-Stück flex / flex*	NW	Art.-Nr.	a (mm)	b (mm)	c (mm)	d (mm)	Notiz
	60	PPTVF5	85	60	160	15	
	80	PPTVF8	120	90	225	30	
	110	PPTVF1	160	115	210	15	
	125	PPTVF2	170	115	260	15	
	160	PPTVF6	210	135	290	15	
	200	PPTVF0	240	155	240	15	

* Abgang reduziert auf Anfrage

FLEXIBLES ABGASSYSTEM (FLEX)

DN 60 – 200 mm

PPH

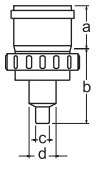
Ablauf mit Muffe		NW	Art.-Nr.	a (mm)	b (mm)	c (mm)	d (mm)	Notiz
		60	PPMA05	63	75	20	40	
		80	PPMA08	68	85	20	40	
		110	PPMA01	63	65	20	40	
		125	PPMA02	75	70	20	40	
		160	PPMA06	85	70	20	40	
		200	PPMA00	150	150	20	40	

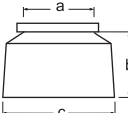
Wetterkragen mit Dichtung		NW	Art.-Nr.	a (mm)	b (mm)	c (mm)	d (mm)	Notiz
		60	PUWK63	63	120	138	-	Kunststoff, schwarz, UV stabilisiert
		80	PUWK90	90	120	138	-	
		110	PUWK25	125	140	190	-	
		125	PUWK45	145	130	190	-	
		160	PUWK75	175	120	190	-	
		200	PUWK00	200	170	250	-	

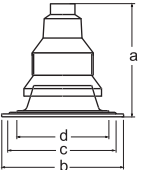
Kaminabschluss flex (komplett)		NW	Art.-Nr.	a (mm)	b (mm)	c (mm)	d (mm)	Notiz
		60	PPSAF5	435	400	350	300	Kunststoff, schwarz, UV stabilisiert
		80	PPSAF8	440	400	350	300	
		110	PPSAF1	440	400	350	300	
		125	PPSAF2	440	400	350	300	
		160	PPSAF6	440	400	350	300	
		200	PPSAF0	550	400	350	300	

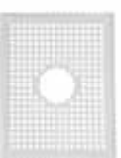
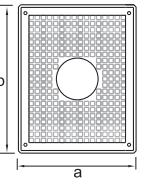
Abdeckblende mit Hinterlüftung		NW	Art.-Nr.	a (mm)	b (mm)	c (mm)	d (mm)	e (mm)	Notiz
		60	ZUBL05	-	-	-	-	-	
		75	ZUBL07	-	-	-	-	-	
		80	ZUBL08	270	340	-	-	-	
		90	ZUBL09	-	-	-	-	-	
		110	ZUBL01	270	340	-	-	-	
		125	ZUBL02	270	340	-	-	-	
		140	ZUBL04	-	-	-	-	-	
		160	ZUBL06	270	340	-	-	-	
		200	ZUBL00	-	-	-	-	-	
		250	ZUBL0V	-	-	-	-	-	

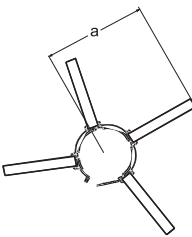
Abstandhalter		NW	Art.-Nr.	a (mm)	b (mm)	c (mm)	d (mm)	e (mm)	Notiz
		60	PPFR05	260	3	-	-	-	
		80	PPFR08	270	4	-	-	-	
		110	PPFR01	285	5	-	-	-	
		125	PPFR02	292	6	-	-	-	
		160	PPFR06	310	7	-	-	-	
		200	PPFR00	330	9	-	-	-	
		250	PPFR0V	355	11	-	-	-	
		315	PPFR03	387	14	-	-	-	